

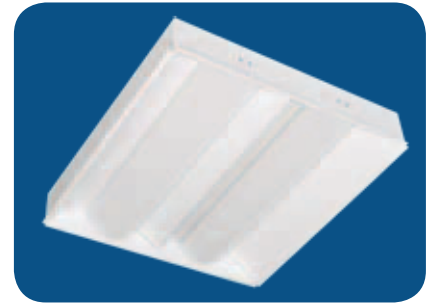

DBI 2x2 ft.

Low Profile Dual Basket T5



FEATURES & SPECIFICATIONS

INTENDED USE

Low profile dedicated to T5 lamping is ideal for shallow plenum spaces. Specification grade, direct / indirect center diffuser luminaire provides smooth and uniform ambient lighting for all commercial and industrial buildings with recessed configurations. Reflected light from matte surfaces provide a softened “sky light” appearance to the modern office environment.

SIZE W x L x H in inches

23.68W x 23.68L x 3.25Dp

LAMP

2 lamp positions.

* Consult factory for 4 lamp

MATERIALS & FEATURES

Housing is die-formed and embossed code 22 gage steel. Luminaire body finish is high reflectance baked white enamel, with matte white reflectors. Wiring knockouts are provided on the back of housing. Center diffuser snaps into place; no tools are required for removal. Diffuser is perforated to maintain even brightness, and provided with an internal, acrylic overlay to obscure lamps.

- Direct / indirect mimics “sky light” appearance
- Matte white reflective surfaces for soft, uniform light distribution
- Recessed perforated center diffuser with acrylic overlay.

MOUNTING

Recessed inverted T-Bar ceilings. Grid mount.

LISTING

Fixture and Ballast: UL Listed.

Ballast: Thermally protected, class P, HPF, Non PCB.

TYPICAL OPTIONS AND ACCESSORIES

Emergency ballasts, whips, and lenses. See options page at the end of the T02Grid section, or contact factory for more details.

ORDERING INFORMATION

Example: **DBIPF224MV**

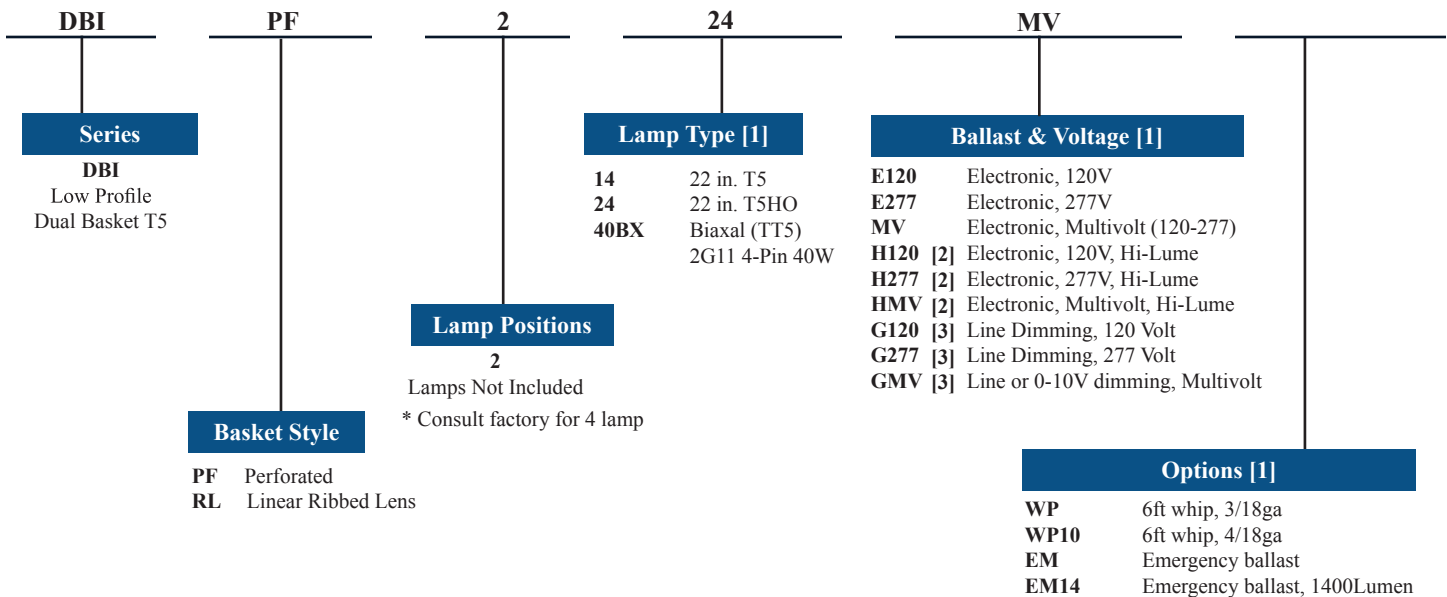

Notes:

- [1] See end of T02Grid for many additional lamps, ballasts, finishes, and options.
 [2] HiLume and multivolt dimming ballasts available for T8 lamps only.
 [3] Dimming ballasts available for T8 & T5HO lamps only.

EM14 ballast required for T5, TT5 & T5HO lamps

Catalog Number:
Notes:

DBI 2x2 ft.

Low Profile Dual Basket T5

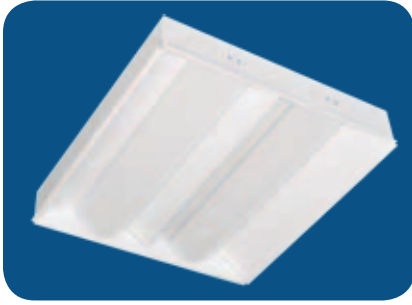

DIMENSIONS

All dimensions are inches. Specifications subject to change without notice.

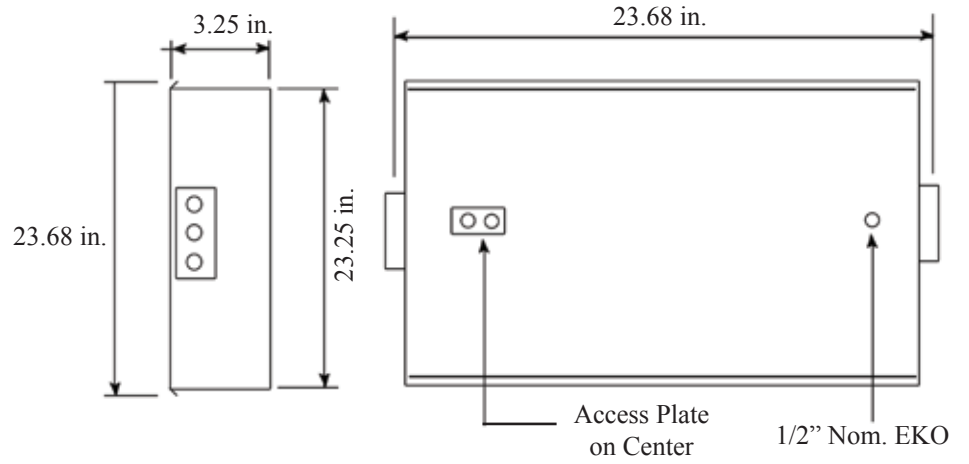

Catalog Number:
Notes:

DBI 2x4 ft.

Low Profile Dual Basket T5

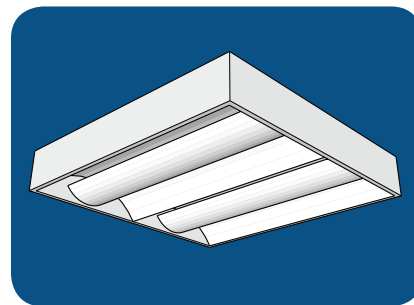

FEATURES & SPECIFICATIONS

INTENDED USE

Low profile dedicated to T5 lamping is ideal for shallow plenum spaces. Specification grade, direct / indirect center diffuser luminaire provides smooth and uniform ambient lighting for all commercial and industrial buildings with recessed configurations. Reflected light from matte surfaces provide a softened “sky light” appearance to the modern office environment.

SIZE W x L x H in inches

23.68W x 47.67L x 3.25Dp

LAMP

2 lamp positions.

* Consult factory for 4 lamp

MATERIALS & FEATURES

Housing is die-formed and embossed code 22 gage steel. Luminaire body finish is high reflectance baked white enamel, with matte white reflectors. Wiring knockouts are provided on the back of housing. Center diffuser snaps into place; no tools are required for removal. Diffuser is perforated to maintain even brightness, and provided with an internal, acrylic overlay to obscure lamps.

- Direct / indirect mimics “sky light” appearance
- Matte white reflective surfaces for soft, uniform light distribution
- Recessed perforated center diffuser with acrylic overlay.

MOUNTING

Recessed inverted T-Bar ceilings. Grid mount.

LISTING

Fixture and Ballast: UL Listed.

Ballast: Thermally protected, class P, HPF, Non PCB.

TYPICAL OPTIONS AND ACCESSORIES

Emergency ballasts, whips, and lenses. See options page at the end of the T02Grid section, or contact factory for more details.

ORDERING INFORMATION

Example: **DBIPF228MVLN35**

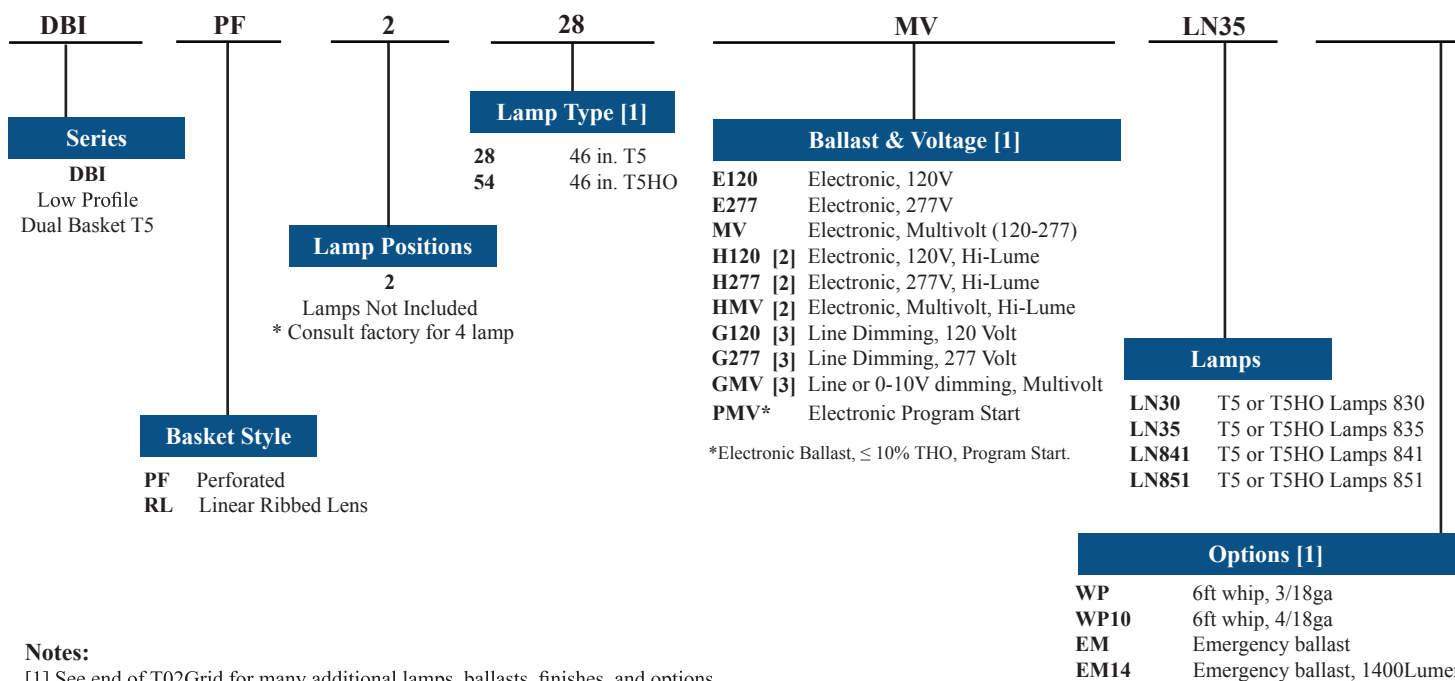

Notes:

[1] See end of T02Grid for many additional lamps, ballasts, finishes, and options.

[2] HiLume and multivolt dimming ballasts available for T8 lamps only.

[3] Dimming ballasts available for T8 & T5HO lamps only.

EM14 ballast required for T5, TT5 & T5HO lamps

Catalog Number:

Notes:

DBI 2x4 ft.

Low Profile Dual Basket T5

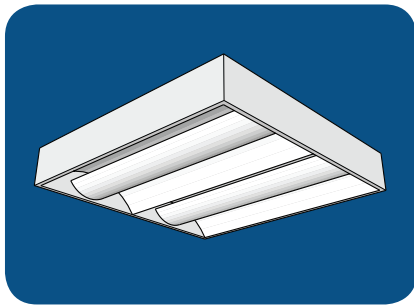

DIMENSIONS

All dimensions are inches. Specifications subject to change without notice.

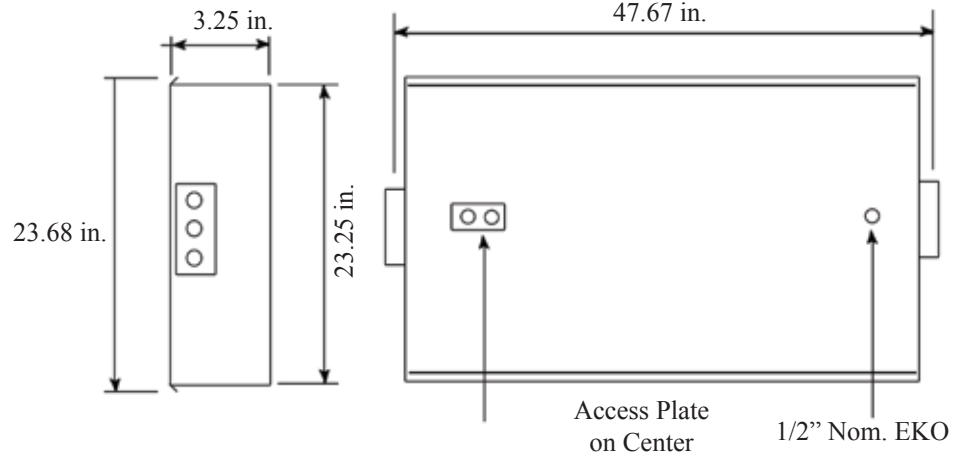

PHOTOMETRIC REFERENCE

Lamping: 2 Lamp 28W T5
Efficiency: 88%

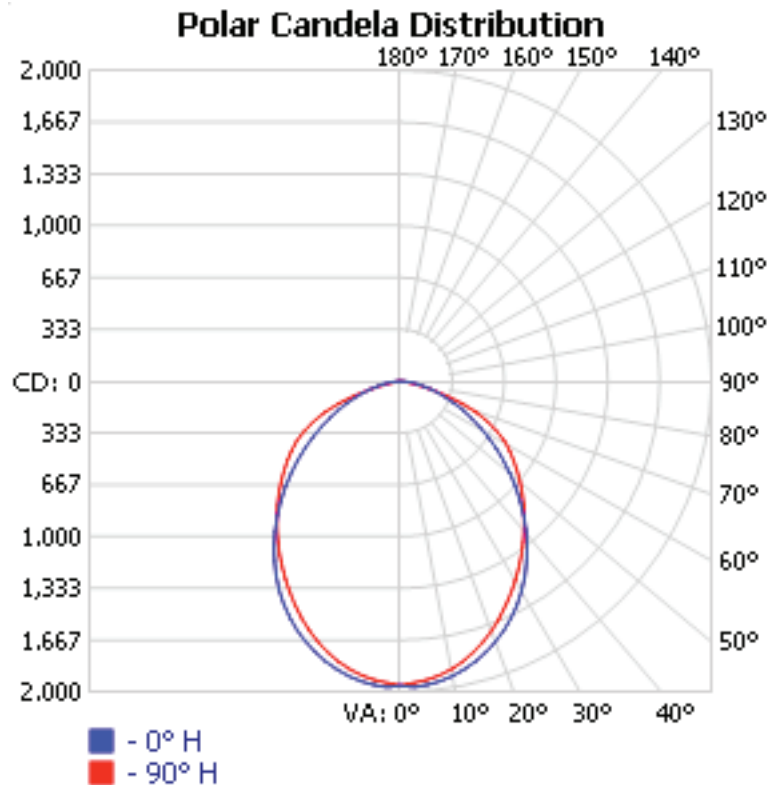

Catalog Number:
Notes:

DBI 2x4 ft.

Low Profile Dual Basket T5



LUMENS PER ZONE					
ZONE	LUMENS	% TOTAL	ZONE	LUMENS	% TOTAL
0-10	184.2	3.8%	90-100	0	0%
10-20	516.5	10.8%	100-110	0	0%
20-30	753.9	15.7%	110-120	0	0%
30-40	868.5	18.1%	120-130	0	0%
40-50	861.8	17.9%	130-140	0	0%
50-60	753.5	15.7%	140-150	0	0%
60-70	558.0	11.6%	150-160	0	0%

ZONAL LUMEN SUMMARY			
ZONE	LUMENS	% LAMP	% LUMINAIRE
0-30	1,454.6	26.6%	30.3%
0-40	2,323.1	42.5%	48.4%
0-60	3,938.3	72.1%	82%
60-90	864.0	15.8%	18%
0-90	4,802.3	88%	100%
90-180	0	0%	0%
0-180	4,802.3	88%	100%

AVERAGE LUMINANCE (CD/M2)					
	0	22.5	45	67.5	90
0	3213	3213	3213	3213	3213
45	2524	2575	2621	2610	2596
55	2139	2296	2471	2528	2536
65	1719	1983	2321	2414	2414
75	1286	1648	1882	1496	1255
85	772	809	376	320	301

COEFFICIENTS OF UTILIZATION - ZONAL CAVITY METHOD

EFFECTIVE FLOOR CAVITY REFLECTANCE: 20%

RCC %:	80				70				50			30			10			0
RW %:	70	50	30	0	70	50	30	0	50	30	20	50	30	20	50	30	20	0
RCR: 0	1.05	1.05	1.05	1.05	1.02	1.02	1.02	.88	.98	.98	.98	.94	.94	.94	.90	.90	.90	.88
1	.96	.92	.89	.86	.94	.90	.87	.76	.87	.84	.82	.83	.81	.79	.80	.78	.77	.75
2	.88	.81	.75	.71	.86	.79	.74	.64	.76	.72	.68	.73	.70	.67	.71	.68	.65	.63
3	.80	.71	.65	.59	.78	.70	.64	.55	.68	.62	.58	.65	.60	.57	.63	.59	.56	.54
4	.74	.64	.56	.50	.72	.62	.55	.48	.60	.54	.49	.58	.53	.49	.56	.52	.48	.46
5	.68	.57	.49	.44	.66	.56	.49	.42	.54	.48	.43	.52	.47	.42	.51	.46	.42	.40
6	.63	.51	.44	.38	.61	.51	.43	.37	.49	.43	.38	.48	.42	.37	.46	.41	.37	.35
7	.58	.47	.39	.34	.57	.46	.39	.33	.45	.38	.34	.43	.38	.33	.42	.37	.33	.31
8	.54	.43	.35	.30	.53	.42	.35	.30	.41	.35	.30	.40	.34	.30	.39	.34	.30	.28
9	.51	.39	.32	.27	.50	.39	.32	.27	.38	.32	.27	.37	.31	.27	.36	.31	.27	.25
10	.48	.36	.29	.25	.47	.36	.29	.24	.35	.29	.25	.34	.29	.25	.33	.28	.25	.23

Catalog Number:
Notes: